

**STIHL**<sup>®</sup>

**STIHL BG-KM**

Instruction Manual





## Contents

KombiSystem	2
Guide to Using this Manual	2
Safety Precautions and Working Techniques	2
Approved KombiEngines	5
Assembling the Unit	5
Mounting the KombiTool	6
Starting / Stopping the Engine	6
Storing the Machine	7
Maintenance and Care	7
Minimize Wear and Avoid Damage	7
Main Parts	9
Specifications	10
Maintenance and Repairs	11
Disposal	11
EC Declaration of Conformity	11



BG-KM

Dear Customer,

Thank you for choosing a quality engineered STIHL product.

It has been built using modern production techniques and comprehensive quality assurance. Every effort has been made to ensure your satisfaction and troublefree use of the product.

Please contact your dealer or our sales company if you have any queries concerning this product.

Your



Dr. Nikolas Stihl

## KombiSystem

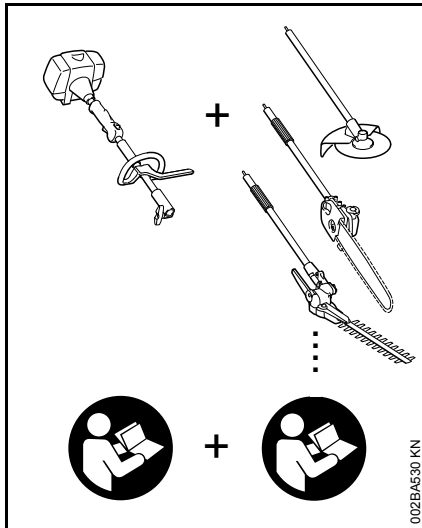

In the STIHL KombiSystem a number of different KombiEngines and KombiTools can be combined to produce a power tool. In this instruction manual the functional unit formed by the KombiEngine **and** KombiTool is referred to as the power tool.

Therefore, the separate instruction manuals for the KombiEngine and KombiTool should be used together for the power tool.

Always read and and make sure you understand **both** instruction manuals before using your power tool for the first time and keep them in a safe place for future reference.

## Guide to Using this Manual

### Pictograms

All the pictograms attached to the machine are shown and explained in this manual.

### Symbols in text



#### WARNING

Warning where there is a risk of an accident or personal injury or serious damage to property.



#### NOTICE

Caution where there is a risk of damaging the machine or its individual components.

### Engineering improvements

STIHL's philosophy is to continually improve all of its products. For this reason we may modify the design, engineering and appearance of our products periodically.

Therefore, some changes, modifications and improvements may not be covered in this manual.

## Safety Precautions and Working Techniques



Special safety precautions must be observed when working with a power tool.



Always read and make sure you understand both instruction manuals (KombiEngine and KombiTool) before using your power tool for the first time and keep them in a safe place for future reference. Non-observance of the safety precautions may result in serious or even fatal injury.

Lend or rent your machine only to persons who are familiar with this model and its operation – do not lend or rent your machine without the KombiEngine and KombiTool instruction manuals.

The blower is designed for blow-sweeping leaves, grass, paper, snow and similar materials, e.g. in gardens, sports stadiums, car parks and driveways. It is also suitable for blow-sweeping forest paths.

Do not use your power tool for any other purpose because of the **increased risk of accidents**.

Only use parts and accessories that are explicitly approved for this power tool by STIHL or are technically identical. If you have any questions in this respect, consult a servicing dealer.

Use only high quality parts and accessories in order to avoid the risk of accidents and damage to the machine.

STIHL recommends the use of genuine STIHL replacement parts. They are specifically designed to match the product and meet your performance requirements.

Never attempt to modify your machine in any way since this may increase the risk of personal injury. STIHL excludes all liability for personal injury and damage to property caused while using unauthorized attachments.

Do not use a pressure washer to clean the unit. The solid jet of water may damage parts of the unit.

### Clothing and Equipment

Wear proper protective clothing and equipment.



Clothing must be sturdy but allow complete freedom of movement. Wear snug-fitting clothing, e.g. an overall and jacket combination, do not wear a work coat.



Avoid any clothing, scarves, neckties, jewelry or anything that could get into the air intake. Tie up and confine long hair (e.g. with a hair net, cap, hard hat, etc.).

Wear sturdy shoes with non-slip soles.

### **WARNING**



To reduce the risk of eye injuries, wear snug-fitting safety glasses in accordance with European Standard EN 166. Make sure the safety glasses are a good fit.

Wear hearing protection, e.g. earplugs or ear muffs.

STIHL offers a comprehensive range of personal protective clothing and equipment.

### Transporting the Power Tool

Always stop the engine.

Transporting by vehicle: Properly secure your power tool to prevent turnover, fuel spillage and damage.

### Before Starting

Check that your power tool is properly assembled and in good condition – refer to appropriate chapters in the KombiEngine and KombiTool instruction manuals.

- A worn blower housing (cracks, nicks, chips) may result in an increased risk of injury from thrown foreign objects.
- If the blower housing is damaged, consult your dealer – STIHL recommends you contact a STIHL servicing dealer.

- Never attempt to modify the controls or safety devices in any way.
- Keep the handles dry and clean – free from oil and dirt – for safe control of the power tool.

**To reduce the risk of accidents**, do not operate your power tool if it is damaged or not properly assembled.

If you use a shoulder strap or full harness: Practice removing and putting down the power tool as you would in an emergency. To avoid damage, do not throw the machine to the ground when practicing.

See also notes on "Before Starting" in the instruction manual of the KombiEngine you are using.

### During Operation

**Do not direct the air blast towards bystanders or animals** since the air flow can blow small objects at great speed.

In the event of impending danger or in an emergency, switch off the engine immediately by moving the slide control / stop switch/button to **STOP** or **0**.

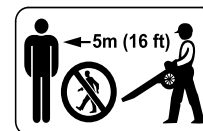

**To reduce the risk of injury**, do not allow any other persons within a radius of 5 meters of your own position.

**To reduce the risk of damage to property**, also maintain this distance from other objects (vehicles, windows).



Your power tool produces toxic exhaust fumes as soon as the engine is running. These fumes may be colorless and odorless and contain unburned hydrocarbons and benzol. Never run the engine indoors or in poorly ventilated locations, even if your model is equipped with a catalytic converter.

Never leave a running machine unattended.

**Take special care in slippery conditions** – damp, snow, ice, on slopes or uneven ground.

When blow-sweeping (in open ground and gardens), watch out for small animals to avoid harming them.

Mufflers with a catalytic converter can become particularly hot.

The dust that occurs during operation may be harmful to health. If dust levels are very high, wear a suitable respirator.

Be particularly alert and cautious when wearing hearing protection because your ability to hear warnings (shouts, alarms, etc.) is restricted.

After finishing work, put the unit down on a level, non-flammable surface. **To reduce the risk of fire**, do not put it down near easily combustible materials (e.g. wood chips, bark, dry grass, fuel).

If your power tool is subjected to unusually high loads for which it was not designed (e.g. heavy impact or a fall), always check that it is in good condition before continuing work – see also notes

in chapter on "Before Starting" in the KombiEngine instruction manual. Make sure the safety devices are working properly. Do not continue operating your power tool if it is damaged. In case of doubt, consult your servicing dealer.

### Using the Machine

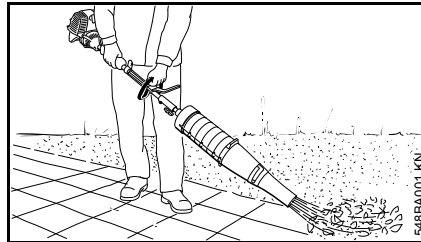

Always hold the power tool firmly with both hands on the handles. Right hand on control handle, left hand on loop handle on drive tube, even if you are left-handed. Wrap fingers and thumbs firmly around the handles.

### **WARNING**

To reduce the risk of injury, operate the machine only with a properly mounted blower tube.

Walk slowly forwards as you work – observe the nozzle outlet at all times – do not walk backwards – **risk of stumbling**.

Watch out for small animals when using the blower on open ground, in yards and gardens.

The machine can be carried on a harness (available as special accessory in some markets) to relieve the weight on your arms.

### Working Technique

To minimize blowing time, use a rake and broom to loosen dirt particles before you start blowing.

Recommended working technique to minimize air pollution:

- If necessary, dampen the surface to be cleaned in order to avoid creating too much dust.
- Do not blow particles in the direction of bystanders, in particular in the direction of children, pets, open windows or freshly washed vehicles. Take special care in such situations.
- Remove the blow-swept debris in rubbish bins – do not blow it onto the neighbor's land.

Recommended working technique to minimize noise:

- Operate your power tool at reasonable times only – not early in the morning, late at night or during midday rest periods when people could be disturbed. Observe local rest periods.
- Operate blowers at the lowest engine speed necessary to accomplish the task.
- Check your blower before starting work. Pay special attention to the muffler, air intakes and air filter.

### Maintenance and Repairs

Service the machine regularly. Do not attempt any maintenance or repair work not described in the KombiTool and

KombiEngine instruction manuals. Have all other work performed by a servicing dealer.

STIHL recommends that you have servicing and repair work carried out exclusively by an authorized STIHL servicing dealer. STIHL dealers are regularly given the opportunity to attend training courses and are supplied with the necessary technical information.

Only use high-quality replacement parts in order to avoid the risk of accidents and damage to the machine. If you have any questions in this respect, consult a servicing dealer.

STIHL recommends the use of genuine STIHL replacement parts. They are specifically designed to match your model and meet your performance requirements.

To reduce the risk of injury, **always shut off the engine** before carrying out any maintenance or repairs or cleaning the machine.

## Approved KombiEngines

### KombiEngines

Only use KombiEngines supplied by STIHL or explicitly approved by STIHL for use with the KombiTool.

This KombiTool may be operated only in combination with the following KombiEngines:

STIHL KM 55 R, KM 56 R, KM 85 R, KM 90, KM 90 R, KM 94 R, KM 100, KM 100 R, KM 110, KM 110 R, KM 130, KM 130 R



### WARNING

Loop-handled power tools must be equipped with a barrier bar.

### Brushcutters with split drive tube

This KombiTool may also be mounted to STIHL brushcutters (basic power tools) with a split drive tube (T models).

Operation of this KombiTool is therefore also permitted on the following power tool model:

STIHL FR 130 T



### WARNING

Refer to the power tool's instruction manual for use of the barrier bar.

## Assembling the Unit

- Push the nozzle onto the blower tube as far as the lug and then rotate it clockwise up to stop to lock in position.



### WARNING

To reduce the risk of injury, operate the unit only with a properly mounted blower tube.

## Mounting the KombiTool

### Mounting the KombiTool

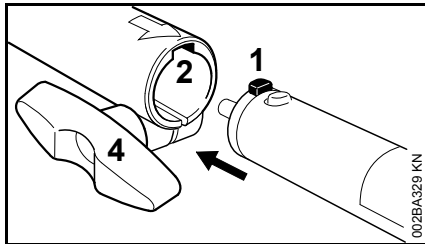

- Push the lug (1) on the drive tube into the slot (2) in the coupling sleeve as far as stop.

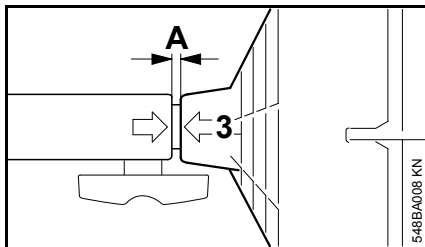

When correctly mounted, the intake screen (3) must be flush with the coupling sleeve (gap 'A' no more than 5 mm).

- Tighten down the wing screw (4) firmly.

### Removing the KombiTool

- Reverse the above sequence to remove the KombiTool.

## Starting / Stopping the Engine

### Starting the Engine

Always follow the operating instructions for the KombiEngine and basic power tool.

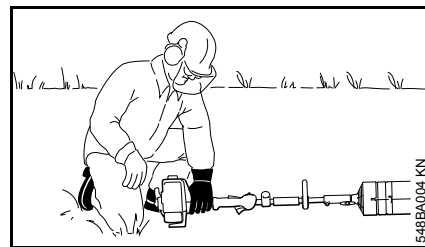
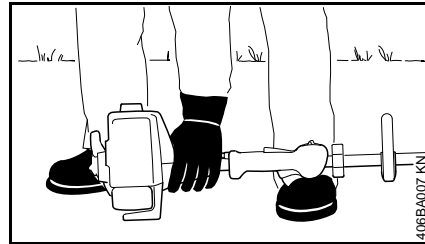

#### NOTICE

Start your machine on a clean surface only to ensure that no dust is sucked in.

- Place the machine securely on the ground and make sure that bystanders are well clear of the nozzle outlet.
- Make sure you have a firm footing, either standing, stooping or kneeling.
- Hold the machine with you left hand and press it down **firmly** – do not touch the controls on the control handle – see KombiEngine or basic power tool instruction manual.



#### NOTICE

Do not stand or kneel on the drive tube.

The starting procedure is now as described in the instruction manual of the KombiEngine or basic power tool you are using.

### Stopping the Engine

- See KombiEngine or basic power tool instruction manual.



## Storing the Machine

For periods of about 3 months or longer

- Clean and inspect the housing.
- If the KombiTool is removed from the KombiEngine and stored separately: Fit the protective cap on the drive tube to avoid dirt getting into the coupling.
- Store the machine in a dry, high or locked location – out of the reach of children and other unauthorized persons.

## Maintenance and Care

The following intervals apply to normal operating conditions only. If your daily working time is longer or operating conditions are difficult (very dusty work area, etc.), shorten the specified intervals accordingly.

### Intake screen

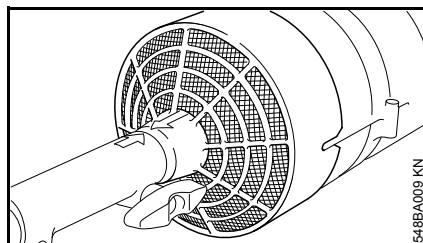

- Check and clean before starting work, after finishing work and when required.
- If damaged, have replaced by dealer<sup>1)</sup>

---

<sup>1)</sup> STIHL recommends a STIHL servicing dealer.

## Minimize Wear and Avoid Damage

Observing the instructions in this manual and the KombiEngine manual helps reduce the risk of unnecessary wear and damage to the power tool.

The power tool must be operated, maintained and stored with the due care and attention described in these instruction manuals.

The user is responsible for all damage caused by non-observance of the safety precautions, operating and maintenance instructions. This includes in particular:

- Alterations or modifications to the product not approved by STIHL.
- Using tools or accessories which are neither approved or suitable for the product or are of a poor quality.
- Using the product for purposes for which it was not designed.
- Using the product for sports or competitive events.
- Consequential damage caused by continuing to use the product with defective components.

### Maintenance Work

All the operations described in the chapter on "Maintenance and Care" must be performed on a regular basis. If these maintenance operations cannot be performed by the owner, they should be performed by a servicing dealer.

STIHL recommends that you have servicing and repair work carried out exclusively by an authorized STIHL

servicing dealer. STIHL dealers are regularly given the opportunity to attend training courses and are supplied with the necessary technical information.

If these maintenance operations are not carried out as specified, the user assumes responsibility for any damage that may occur. Among other parts, this includes:

- Corrosion and other consequential damage resulting from improper storage.
- Damage to the product resulting from the use of poor quality replacement parts.

### **Parts Subject to Wear and Tear**

Some parts of the power tool are subject to normal wear and tear even during regular operation in accordance with instructions and, depending on the type and duration of use, have to be replaced in good time. Among other parts, this includes:

- Nozzle
- Intake screen

## Main Parts

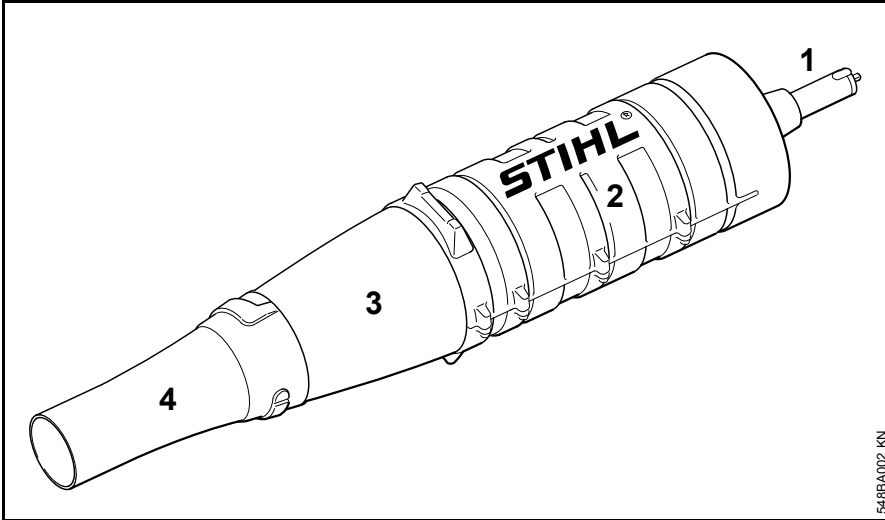

- 1 Drive tube
- 2 Blower housing
- 3 Blower tube
- 4 Nozzle

548BA002 KN

## Specifications

### Maximum air flow rate (with round nozzle)

depending on KM or FR model being used

875 - 1025 m<sup>3</sup>/h

### Air velocity (with round nozzle)

depending on KM or FR model being used

60 - 70 m/s

### Weight

1.8 kg

### Noise and Vibration Data

Noise and vibration data measurements on power tools with the BG-KM KombiTool include idling and rated maximum speed in a ratio of 1:6.

For further details on compliance with Vibration Directive 2002/44/EC see [www.stihl.com/vib/](http://www.stihl.com/vib/)

#### Sound pressure level $L_{peq}$ to ISO 22868

KM 55 R with loop handle: 95 dB(A)

KM 56 R with loop handle: 96 dB(A)

KM 85 R with loop handle: 97 dB(A)

KM 90 R with loop handle: 95 dB(A)

KM 94 R with loop handle: 95 dB(A)

KM 100 R with loop handle: 95 dB(A)

KM 130 R with loop handle: 97 dB(A)

FR 130 T: 96 dB(A)

#### Sound power level $L_w$ to ISO 22868

KM 55 R with loop handle: 106 dB(A)

KM 56 R with loop handle: 107 dB(A)

KM 85 R with loop handle: 108 dB(A)

KM 90 R with loop handle: 107 dB(A)

KM 94 R with loop handle: 106 dB(A)

KM 100 R with loop handle: 107 dB(A)

KM 130 R with loop handle: 109 dB(A)

#### Sound power level $L_{weq}$ to ISO 22868

FR 130 T: 108 dB(A)

#### Vibration measurement $a_{hv,eq}$ to ISO 22867

	Handle, left	Handle, right
KM 55 R with loop handle:	4.6 m/s <sup>2</sup>	7.0 m/s <sup>2</sup>
KM 56 R with loop handle:	4.7 m/s <sup>2</sup>	6.7 m/s <sup>2</sup>
KM 85 R with loop handle:	4.4 m/s <sup>2</sup>	8.2 m/s <sup>2</sup>
KM 90 R with loop handle:	3.1 m/s <sup>2</sup>	5.9 m/s <sup>2</sup>
KM 94 R with loop handle:	4.8 m/s <sup>2</sup>	5.9 m/s <sup>2</sup>

The K-factor in accordance with Directive 2006/42/EC is 2.5 dB(A) for the sound pressure level and sound power level; the K-factor in accordance with Directive 2006/42/EC is 2.0 m/s<sup>2</sup> for the vibration measurement.

### REACH

REACH is an EC regulation and stands for the Registration, Evaluation, Authorisation and Restriction of Chemical substances.

For information on compliance with the REACH regulation (EC) No. 1907/2006 see [www.stihl.com/reach](http://www.stihl.com/reach).

## Maintenance and Repairs

Users of this machine may only carry out the maintenance and service work described in this user manual. All other repairs must be carried out by a servicing dealer.

STIHL recommends that you have servicing and repair work carried out exclusively by an authorized STIHL servicing dealer. STIHL dealers are regularly given the opportunity to attend training courses and are supplied with the necessary technical information.

When repairing the machine, only use replacement parts which have been approved by STIHL for this power tool or are technically identical. Only use high-quality replacement parts in order to avoid the risk of accidents and damage to the machine.

STIHL recommends the use of original STIHL replacement parts.

Original STIHL parts can be identified by the STIHL part number, the **STIHL** logo and the STIHL parts symbol  (the symbol may appear alone on small parts).

## Disposal

Observe all country-specific waste disposal rules and regulations.

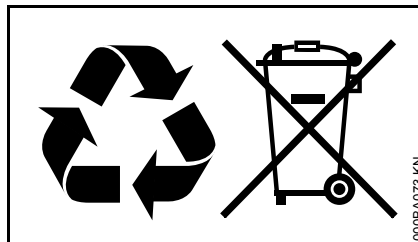

STIHL products must not be thrown in the garbage can. Take the product, accessories and packaging to an approved disposal site for environment-friendly recycling.

Contact your STIHL servicing dealer for the latest information on waste disposal.

## EC Declaration of Conformity

ANDREAS STIHL AG & Co. KG  
Badstr. 115  
D-71336 Waiblingen

Germany

declare in exclusive responsibility that the product

Category: Blower  
KombiTool

Make: STIHL

Type: BG-KM

Serial identification: 4606

conforms to the relevant provisions of Directives 2006/42/EC, 2014/30/EU and 2000/14/EC and has been developed and manufactured in compliance with the following standards in the versions valid on the date of production:

EN ISO 12100-1, EN ISO 12100-2 (in conjunction with the specified KM and FR models)

The measured and guaranteed sound power levels were determined according to Directive 2000/14/EC, Annex V, using the ISO 11094 standard.

### Measured sound power level

with KM 55 R:	104 dB(A)
with KM 56 R:	106 dB(A)
with KM 85 R:	106 dB(A)
with KM 90 R:	105 dB(A)
with KM 94 R:	108 dB(A)
with KM 100 R:	105 dB(A)
with KM 110 R:	105 dB(A)
with KM 130 R:	108 dB(A)
with FR 130 T:	107 dB(A)

*English*

**Guaranteed sound power level**

with KM 55 R:	106 dB(A)
with KM 56 R:	108 dB(A)
with KM 85 R:	108 dB(A)
with KM 90 R:	107 dB(A)
with KM 94 R:	110 dB(A)
with KM 100 R:	107 dB(A)
with KM 110 R:	107 dB(A)
with KM 130 R:	110 dB(A)
with FR 130 T:	109 dB(A)

Technical documents deposited at:

ANDREAS STIHL AG & Co. KG  
Produktzulassung (Product Licensing)

The year of manufacture is applied to  
the power tool.

Done at Waiblingen, 28.10.2016

ANDREAS STIHL AG & Co. KG



Thomas Elsner

Director Product Management and  
Services





0458-548-0121-A

englisch



[www.stihl.com](http://www.stihl.com)



0458-548-0121-A