

STIHL[®]

STIHL BR 700

Instruction Manual



Contents

| | |
|---|----|
| Guide to Using this Manual | 2 |
| Safety Precautions and Working Techniques | 2 |
| Assembling the Unit | 7 |
| Adjusting the Throttle Cable | 9 |
| Fitting the Harness | 9 |
| Fuel | 10 |
| Fueling | 11 |
| Winter Operation | 12 |
| Information Before You Start | 13 |
| Starting / Stopping the Engine | 13 |
| Operating Instructions | 15 |
| Replacing the Air Filter | 16 |
| Adjusting the Carburetor | 16 |
| Spark Plug | 17 |
| Storing the Machine | 18 |
| Inspections and Maintenance by Dealer | 18 |
| Maintenance and Care | 19 |
| Minimize Wear and Avoid Damage | 21 |
| Main Parts | 22 |
| Specifications | 23 |
| Maintenance and Repairs | 24 |
| Disposal | 24 |
| EC Declaration of Conformity | 24 |

Dear Customer,

Thank you for choosing a quality engineered STIHL product.

It has been built using modern production techniques and comprehensive quality assurance. Every effort has been made to ensure your satisfaction and troublefree use of the product.

Please contact your dealer or our sales company if you have any queries concerning this product.

Your



Dr. Nikolas Stihl

STIHL®

Guide to Using this Manual

Pictograms

The meanings of the pictograms attached to the machine are explained in this manual.

Depending on the model concerned, the following pictograms may be attached to your machine.



Fuel tank; fuel mixture of gasoline and engine oil



Intake air: Winter operation



Intake air: Summer operation

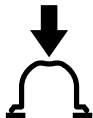

Operate manual fuel pump

Symbols in text



WARNING

Warning where there is a risk of an accident or personal injury or serious damage to property.



NOTICE

Caution where there is a risk of damaging the machine or its individual components.

Engineering improvements

STIHL's philosophy is to continually improve all of its products. For this reason we may modify the design, engineering and appearance of our products periodically.

Therefore, some changes, modifications and improvements may not be covered in this manual.

Safety Precautions and Working Techniques



Special safety precautions must be observed when working with a power tool.



It is important that you read the instruction manual before first use and keep it in a safe place for future reference. Non-observance of the instruction manual may result in serious or even fatal injury.

Observe all applicable local safety regulations, standards and ordinances.

If you have not used this model before: Have your dealer or other experienced user show you how it is operated or attend a special course in its operation.

Minors should never be allowed to use this product.

Keep bystanders, especially children, and animals away from the work area.

When the power tool is not in use, put it in a place where it does not endanger others. Secure it against unauthorized use.

The user is responsible for avoiding injury to third parties or damage to their property.

Do not lend or rent your power tool without the instruction manual. Be sure that anyone using your power tool understands the information contained in this manual.

The use of noise emitting power tools may be restricted to certain times by national or local regulations.

Do not operate your power tool if any of its components are damaged.

Do not use a pressure washer to clean your power tool. The solid jet of water may damage parts of the power tool.

Accessories and Spare Parts

Only use parts and accessories that are explicitly approved for this power tool by STIHL or are technically identical. If you have any questions in this respect, consult a servicing dealer. Use only high quality parts and accessories in order to avoid the risk of accidents and damage to the machine.

STIHL recommends the use of original STIHL replacement parts and accessories. They are specifically designed to match the product and meet your performance requirements.

Never attempt to modify your machine in any way since this may increase the risk of personal injury. STIHL excludes all liability for personal injury and damage to property caused while using unauthorized attachments.

Physical Condition

To operate this power tool you must be rested, in good physical condition and mental health.

If you have any condition that might be aggravated by strenuous work, check with your doctor before operating a power tool.

Persons with pacemakers only: The ignition system of your power tool produces an electromagnetic field of a very low intensity. This field may interfere with some pacemakers. To reduce health risks, STIHL recommends that persons with pacemakers consult their physician and the pacemaker manufacturer before operating this power tool.

Do not operate the sprayer if you are under the influence of any substance (drugs, alcohol) which might impair vision, dexterity or judgment.

Intended Use

The blower is designed for blow-sweeping leaves, grass, paper and similar materials, e.g. in gardens, sports stadiums, car parks and driveways. It is also suitable for blow-sweeping forest paths.

Do not blow-sweep hazardous materials.

Do not use the machine for any other purpose because of the increased risk of accidents and damage to the machine. Never attempt to modify the product in any way since this may result in accidents or damage to the product.

Clothing and Equipment

Wear proper protective clothing and equipment.



Clothing must be sturdy but allow complete freedom of movement. Wear snug-fitting clothing, an overall and jacket combination, do not wear a work coat.



Avoid clothing with loose drawstrings, laces and ribbons, scarves, neckties, jewelry or anything that could be sucked into the air intake in the side and bottom of the machine. Tie up and confine long hair (e.g. with a hair net, cap, hard hat, etc.).

Wear sturdy shoes with non-slip soles.



WARNING



To reduce the risk of eye injuries, wear close-fitting safety glasses in accordance with European Standard EN 166. Make sure the safety glasses are a comfortable and snug fit.

Wear hearing protection, e.g. earplugs or ear muffs.

STIHL offers a comprehensive range of personal protective clothing and equipment.

Transporting the Power Tool

Always stop the engine.

Transporting in a vehicle:

- Properly secure your power tool to prevent turnover, fuel spillage and damage.

Fueling



Gasoline is an extremely flammable fuel. Keep clear of naked flames. Do not spill any fuel – do not smoke.

Always **shut off the engine** before refueling.

Do not fuel a hot engine – fuel may spill and **cause a fire**.

Always remove the power tool from your back and put it on the ground before refueling. Fuel the unit only when it is standing on the ground.

Open the fuel cap carefully to allow any pressure build-up in the tank to release slowly and avoid fuel spillage.

Fuel your power tool only in well-ventilated areas. If you spill fuel, wipe the machine immediately – if fuel gets on your clothing, change immediately.



Check for leakage. To reduce the **risk of serious or fatal burn injuries**, do not start or run the engine until leak is fixed.

Screw-type fuel cap



After fueling, tighten down the screw-type fuel cap as securely as possible.

This reduces the risk of unit vibrations causing the fuel cap to loosen or come off and spill quantities of fuel.

Before Starting

Check that your power tool is properly assembled and in good condition – refer to appropriate chapters in the instruction manual.

- Check the fuel system for leaks, paying special attention to visible parts such as the tank cap, hose connections and the manual fuel pump (on machines so equipped). If there are any leaks or damage, do not start the engine – **risk of fire**. Have your machine repaired by a servicing dealer before using it again.
- Throttle trigger must move freely and spring back to the idle position when released.
- The setting lever must move easily to **STOP** or **0**
- The blower tubes must be properly assembled.
- Keep the handles dry and clean – free from oil and dirt – for safe control of the power tool.
- Check that the spark plug boot is secure – a loose boot may cause arcing that could ignite combustible fumes **and cause a fire**.
- Never attempt to modify the controls or the safety devices in any way.

- Check condition of blower housing.
- Check condition of harness straps and backpack – replace damaged or worn straps.

A worn blower housing (cracks, nicks, chips) may result in an increased risk of injury from thrown foreign objects. If the blower housing is damaged, consult your dealer – STIHL recommends you contact a STIHL servicing dealer.

To reduce the risk of accidents, do not operate your power tool if it is not properly assembled and in good condition.

For emergencies: Practice quickly opening the fastener on the waist belt, loosening the shoulder straps and setting down the unit.

Starting the Engine

Start the engine at least 3 meters from the fueling spot, outdoors only.

Your power tool is designed to be operated by one person only. Do not allow other persons in the work area – even when starting.

Do not drop start the power tool – start the engine as described in the instruction manual.

Place the power tool on level ground, make sure you have secure footing, hold the power tool securely.

As soon as the engine starts, the air flow may throw small objects (e.g. stones) in your direction.

During Operation

In the event of impending danger or in an emergency, switch off the engine immediately by moving the setting lever to **STOP** or **0**.

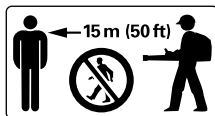

To reduce the risk of injury from thrown objects, do not allow any other persons within 15 meters of your own position.

To reduce the risk of damage to property, also maintain this distance from other objects (vehicles, windows).



Do not direct the air blast towards bystanders or animals since the air flow can blow small objects at great speed.

When blow-sweeping (in open ground and gardens), watch out for small animals to avoid harming them.

Never leave a running machine unattended.

Take special care in slippery conditions – damp, snow, ice, on slopes and uneven ground.

Watch out for obstacles: Be careful of refuse, tree stumps, roots and ditches which could **cause you to trip or stumble**.

Never work on a ladder or any other insecure support.

Be particularly alert and cautious when wearing hearing protection because your ability to hear warnings (shouts, alarms, etc.) is restricted.

Work calmly and carefully – in daylight conditions and only when visibility is good. Stay alert so as not to endanger others.

To reduce the risk of accidents, take a break in good time to avoid tiredness or exhaustion.



Your power tool produces **toxic exhaust fumes** as soon as the engine is running. These fumes may be colorless and odorless and contain unburned hydrocarbons and benzol. Never run the engine indoors or in poorly ventilated locations, even if your model is equipped with a catalytic converter.

To reduce the risk of serious or fatal injury from breathing toxic fumes, ensure proper ventilation when working in trenches, hollows or other confined locations.

To reduce the risk of accidents, stop work immediately in the event of nausea, headache, visual disturbances (e.g. reduced field of vision), problems with hearing, dizziness, deterioration in ability to concentrate. Apart from other possibilities, these symptoms may be caused by an excessively high concentration of exhaust gases in the work area.

To reduce the risk of fire, do not smoke while operating or standing near your power tool. Note that combustible fuel vapor may escape from the fuel system. If dust levels are very high, always wear a suitable respirator.

Operate your power tool so that it produces a minimum of noise and emissions – do not run the engine unnecessarily, accelerate the engine only when working.

After finishing work, put the unit down on a level, non-flammable surface. **To reduce the risk of fire**, do not put it down near easily combustible materials (e.g. wood chips, bark, dry grass, fuel).

If your power tool is subjected to unusually high loads for which it was not designed (e.g. heavy impact or a fall), always check that it is in good condition before continuing work – see also "Before Starting Work". Check the fuel system in particular for leaks and make sure the safety devices are working properly. Do not continue operating your power tool if it is damaged. In case of doubt, consult your servicing dealer.

Using the Blower

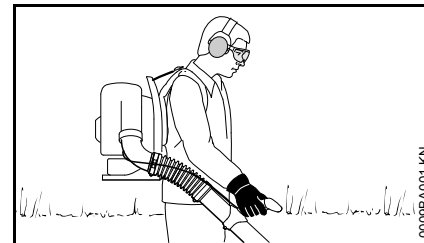

The machine is carried as a backpack. Hold and control the blower tube with your right hand on the control handle.

Walk slowly forwards as you work – observe the nozzle outlet at all times – do not walk backwards – **risk of stumbling**.

Always shut off the engine before taking the unit off your back.

Working Technique

To minimize blowing time, use a rake and broom to loosen dirt particles before you start blowing.

Recommended working technique to minimize air pollution:

- If necessary, dampen the surface to be cleaned in order to avoid creating too much dust.
- Do not blow particles in the direction of bystanders, in particular in the direction of children, pets, open windows or freshly washed vehicles. Take special care in such situations.
- Remove the blow-swept debris in rubbish bins – do not blow it onto the neighbor's land.

Recommended working technique to minimize noise:

- Operate your power tool at reasonable times only – not early in the morning, late at night or during midday rest periods when people could be disturbed. Observe local rest periods.
- Operate blowers at the lowest engine speed necessary to accomplish the task.
- Check your blower before starting work. Pay special attention to the muffler, air intakes and air filter.

Vibrations

Prolonged use of the power tool may result in vibration-induced circulation problems in the hands (whitefinger disease).

No general recommendation can be given for the length of usage because it depends on several factors.

The period of usage is prolonged by:

- Keeping your hands warm
- Work breaks

The period of usage is shortened by:

- Any personal tendency to suffer from poor circulation (symptoms: frequently cold fingers, itching).
- Low outside temperatures.
- Gripping force (a tight grip hinders circulation).

Continual and regular users should monitor closely the condition of their hands and fingers. If any of the above symptoms appear (e.g. tingling sensation in fingers), seek medical advice.

Maintenance and Repairs

Service the machine regularly. Do not attempt any maintenance or repair work not described in the instruction manual. Have all other work performed by a servicing dealer.

STIHL recommends that you have servicing and repair work carried out exclusively by an authorized STIHL servicing dealer. STIHL dealers are

regularly given the opportunity to attend training courses and are supplied with the necessary technical information.

Only use high-quality replacement parts in order to avoid the risk of accidents and damage to the machine. If you have any questions in this respect, consult a servicing dealer.

STIHL recommends the use of genuine STIHL replacement parts. They are specifically designed to match your model and meet your performance requirements.

To reduce the risk of injury, **always shut off the engine** before carrying out any maintenance or repairs or cleaning the machine. – Exception: Carburetor and idle speed adjustments.

Do not turn the engine over on the starter with the spark plug boot or spark plug removed since there is otherwise a **risk of fire** from uncontained sparking.

Do not service or store your machine near open flames.

Check the fuel filler cap for leaks at regular intervals.

Use only a spark plug of the type approved by STIHL and make sure it is in good condition – see "Specifications".

Inspect the ignition lead (insulation in good condition, secure connection).

Check the condition of the muffler.

To reduce the **risk of fire and damage to hearing**, do not operate your machine if the muffler is damaged or missing.

Do not touch a hot muffler since **burn injury** will result.

Vibration behavior is influenced by the condition of the AV elements – check the AV elements at regular intervals.

Shut off the engine before rectifying problems.

Assembling the Unit

Mounting the Hose Clamps and Pleated Hose

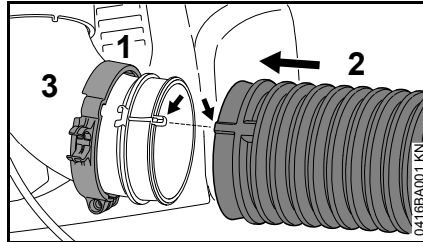

- Push the hose clamp (1) (with retainer for throttle cable) onto the elbow (3) – the positioning marks must face to the left.
- Push the pleated hose (2) over the elbow (3).

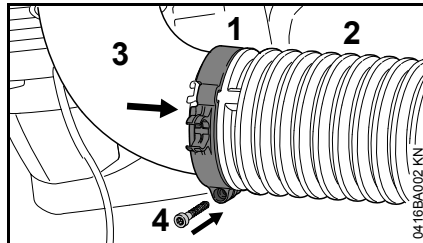

- Push the hose clamp (1) onto the pleated hose (2).
- Line up the positioning marks on the hose clamp (1) and elbow (3) – the screw eye faces down.
- Secure the hose clamp (1) with the screw (4).

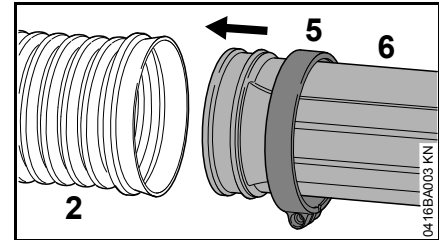

- Push the hose clamp (5) (without retainer for throttle cable) onto the blower tube (6) – the positioning marks must face to the right.
- Push the blower tube (6) into the pleated hose (2).

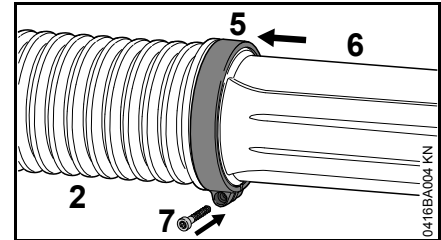

- Push the hose clamp (5) onto the pleated hose (2).
- Line up the hose clamp (5) and blower tube (6) – as shown.
- Secure the hose clamp (5) with the screw (7).

Mounting the nozzle

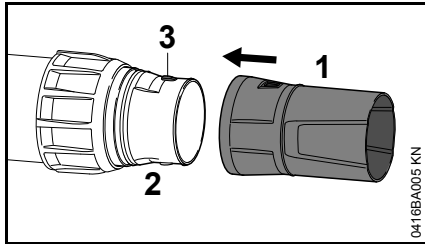

- Push the nozzle (1) onto the blower tube (2) and engage it on the lugs (3).

Removing the Nozzle

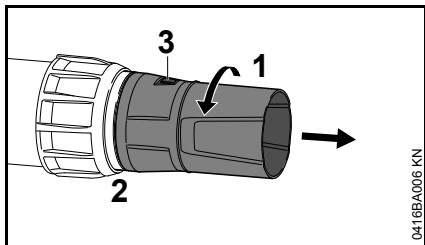

- Rotate the nozzle (1) in the direction of the arrow until the lugs (3) are covered.
- Pull the nozzle (1) off the blower tube (2).

Mounting the Control Handle

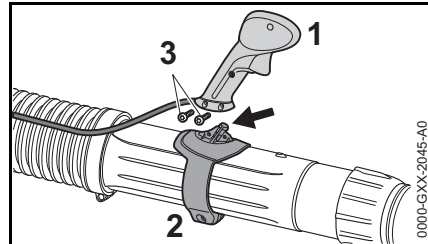

- Push the control handle (1) onto the mount (2).
- Insert and tighten down the screws (3).

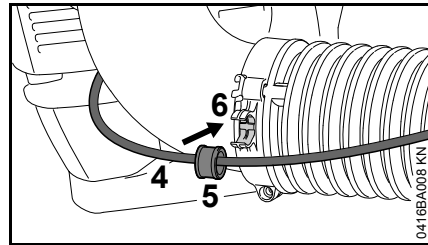

- Engage the throttle cable (4) with sleeve (5) in the hose clamp (6).

Adjusting the control handle

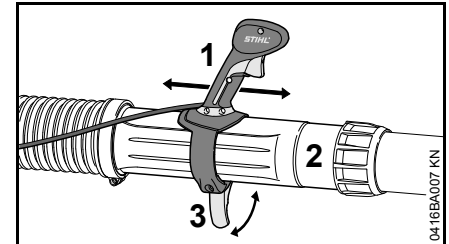

- Open the clamping lever (3).
- Move the control handle (1) along the blower tube (2) to the most comfortable position.
- Close the clamping lever (3).

Adjusting the Blower Tube

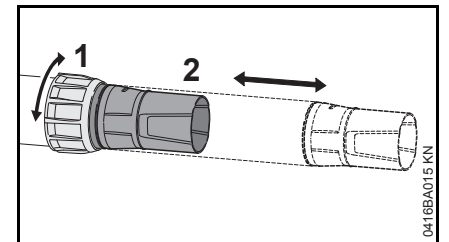

- Loosen the union nut (1).
- Pull the blower tube (2) out to the required length.
- Tighten the union nut (1).

Wear Mark on Nozzle

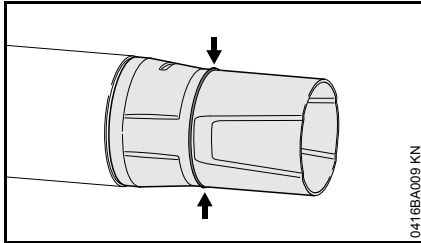

0416BA009 KN

The front end of the nozzle wears away due to abrasive ground contact during operation. The nozzle is subject to normal wear and tear and must be replaced when the wear mark is reached.

Transport Aid

When storing or transporting the machine:

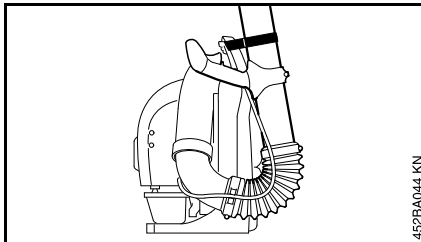

452BA044 KN

- Secure the blower tube to the handle on the backplate with the hook and loop fastener.

Adjusting the Throttle Cable

It may be necessary to correct the adjustment of the throttle cable after assembling the machine or after a prolonged period of operation.

Adjust the throttle cable only when the unit is completely and properly assembled.

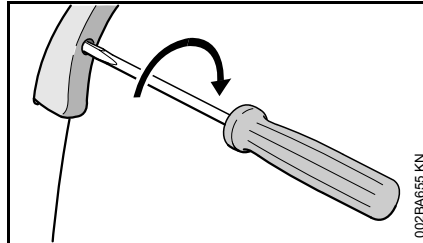

002BA655 KN

- Set the throttle trigger to the full throttle position.
- Carefully rotate the screw in the throttle trigger in the direction of the arrow until you feel initial resistance. Then rotate it another half turn in the same direction.

Fitting the Harness

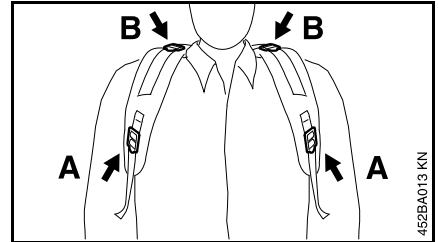

452BA013 KN

- Adjust the harness straps so that the backplate fits snugly and securely against your back.
- A Adjust height
B Adjust angle

Tightening the harness straps

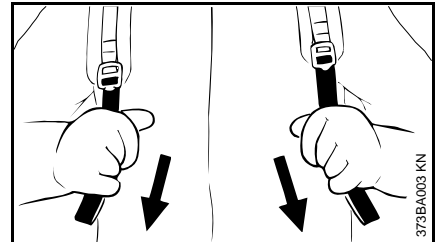

373BA003 KN

- Pull the ends of the straps downward.

Loosening the harness straps

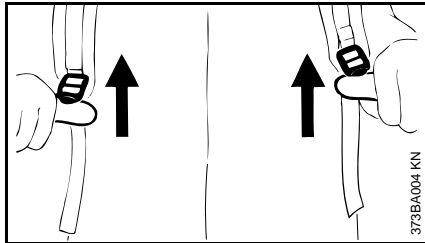

- Lift the tabs of the sliding adjusters.

Fuel

Your engine requires a mixture of gasoline and engine oil.

WARNING

For health reasons, avoid direct skin contact with gasoline and avoid inhaling gasoline vapor.

STIHL MotoMix

STIHL recommends the use of STIHL MotoMix. This ready-to-use fuel mix contains no benzol or lead, has a high octane rating and ensures that you always use the right mix ratio.

STIHL MotoMix uses STIHL HP Ultra two-stroke engine oil for an extra long engine life.

MotoMix is not available in all markets.

Mixing Fuel

NOTICE

Unsuitable fuels or lubricants or mix ratios other than those specified may result in serious damage to the engine. Poor quality gasoline or engine oil may damage the engine, sealing rings, hoses and the fuel tank.

Gasoline

Use only high-quality **brand-name** gasoline with a minimum octane rating of 90 – leaded or unleaded.

If your machine is equipped with a catalytic converter, you must use unleaded gasoline.

NOTICE

A few tankfuls of leaded gasoline will greatly reduce the efficiency of the catalytic converter.

Gasoline with an ethanol content of more than 10% can cause running problems in engines with a manually adjustable carburetor and should not be used in such engines.

Engines equipped with M-Tronic deliver full power when run on gasoline with an ethanol content of up to 25% (E25).

Engine oil

Use only high-quality two-stroke engine oil – preferably **STIHL HP, HP Super or HP Ultra, which are specially formulated for use in STIHL engines. HP Ultra guarantees high performance and a long engine life.**

These engine oils are not available in all markets.

Use only **STIHL 50:1 two-stroke engine oil** for the fuel mix in models with a catalytic converter.

Mix Ratio

STIHL 50:1 two-stroke engine oil: 50 parts gasoline to 1 part oil

Examples

| Gasoline Liters | STIHL engine oil 50:1 Liters (ml) |
|--------------------|--------------------------------------|
| 1 | 0.02 (20) |
| 5 | 0.10 (100) |
| 10 | 0.20 (200) |
| 15 | 0.30 (300) |
| 20 | 0.40 (400) |
| 25 | 0.50 (500) |

- Use a canister approved for storing fuel. Pour oil into canister first, then add gasoline and mix thoroughly.

Storing Fuel

Store fuel only in approved safety-type fuel canisters in a dry, cool and safe location protected from light and the sun.

Fuel mix ages – only mix sufficient fuel for a few weeks work. Do not store fuel mix for longer than 30 days. Exposure to light, the sun, low or high temperatures can quickly make the fuel mix unusable.

STIHL MotoMix may be stored for up to 2 years without any problems.

- Thoroughly shake the mixture in the canister before fueling your machine.

WARNING

Pressure may build up in the canister – open it carefully.

- Clean the fuel tank and canister from time to time.

Dispose of remaining fuel and cleaning fluid properly in accordance with local regulations and environmental requirements.

Fueling



Preparations

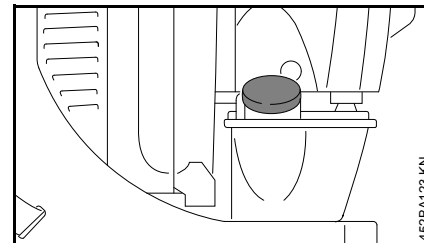

- Before fueling, clean the filler cap and the area around it to ensure that no dirt falls into the tank.

Opening screw-type tank cap

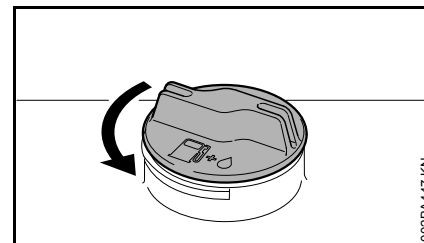

- Turn the cap counterclockwise until it can be removed from the tank opening.
- Remove the cap.

Filling up with fuel

Take care not to spill fuel while fueling and do not overfill the tank. STIHL recommends you use the STIHL filler nozzle (special accessory).

Closing screw-type tank cap

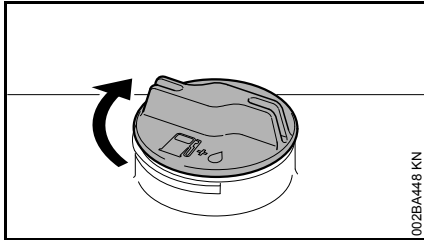

- Place the cap in the opening.
- Turn the cap clockwise as far as stop and tighten it down as firmly as possible by hand.

Winter Operation



At temperatures below 10°C:

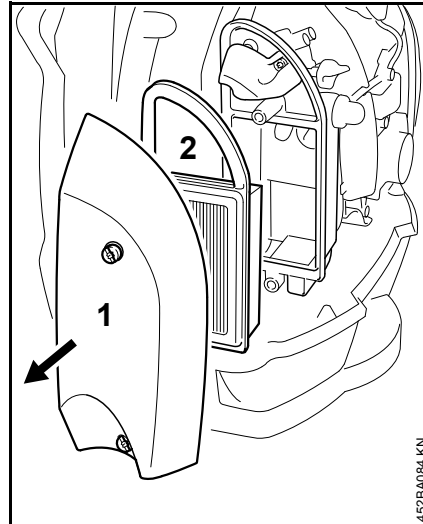

- Remove the filter cover (1) and air filter element (2).

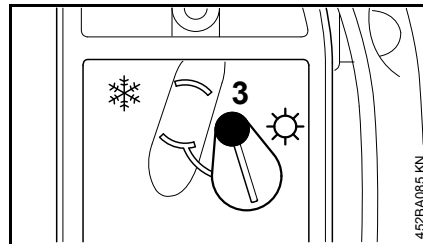

- Loosen the screw (3).

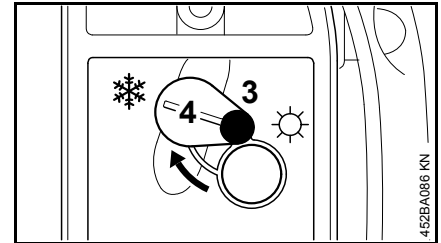

- Swing the shutter (4) to the winter position (❄).
- Tighten down the screw (3) firmly.
- Refit the filter cover and air filter element.

At temperatures above 20°C:

- Always return the shutter (4) to the summer position (☀).



since there is otherwise a risk of engine running problems due to overheating.

Information Before You Start



NOTICE

With the engine stopped, check the following parts before starting and clean if necessary:

- Base plate
- Intake screen between backplate and engine

Positions of Setting Lever

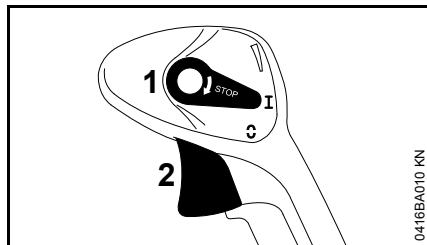

- 1 Setting lever
- 2 Throttle trigger

Position "I"

Engine runs or is ready to start. Throttle trigger (2) can be moved to any position.

Position "0"

Ignition is interrupted, engine stops. The setting lever (1) is not locked in this position. It springs back to position "I". The ignition is switched on again.

Fixed throttle

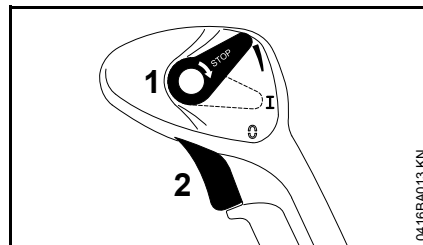

The throttle trigger (2) can be locked in any position.

To disengage the lock:

- Return the setting lever (1) to position "I".

Starting / Stopping the Engine

Starting the Engine

- Observe safety precautions.



NOTICE

Start your unit on a clean, dust-free surface only to ensure that no dust is sucked in.

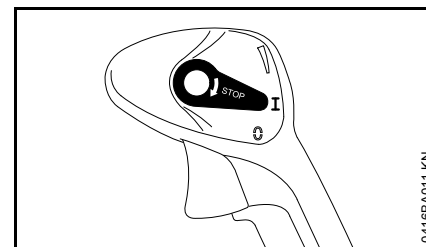

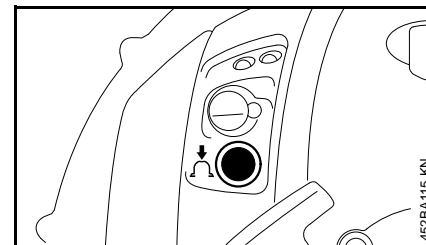

- Move the setting lever to I

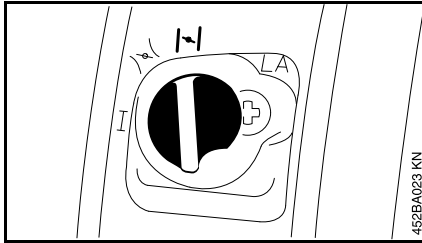

- Press the manual fuel pump bulb at least five times – even if the bulb is filled with fuel.

Cold engine (cold start)



- Turn the choke knob to .

Warm engine (warm start)

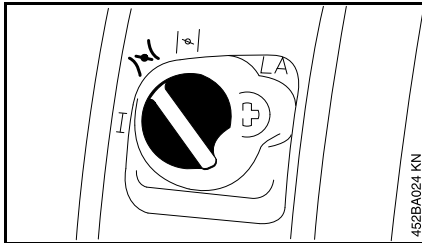

- Turn the choke knob to .

Also use this setting if the engine has been running but is still cold.

Cranking

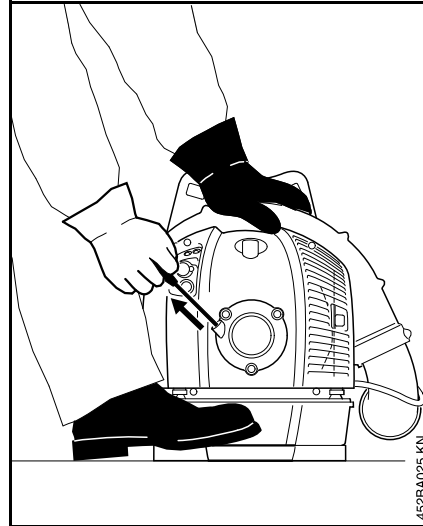

- Place the unit securely on the ground and make sure that bystanders are well clear of the nozzle outlet.
- Make sure you have a firm footing: Hold the unit with your left hand on the housing and put one foot against the base plate to prevent it slipping.
- Pull the starter grip slowly with your right hand until you feel it engage and then give it a brisk strong pull. Do not pull out the starter rope to full length – **it might otherwise break.**
- Do not let the starter grip snap back. Guide it slowly back into the housing so that the starter rope can rewind properly.
- Crank the engine until it begins to fire. After no more than three attempts, turn the choke knob to .

When engine begins to fire

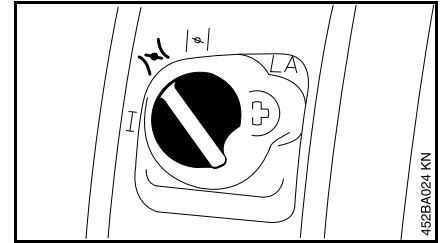

If the engine is **cold**:

- Turn the choke knob to  and continue cranking until the engine runs.

If the engine is **warm**:

- continue cranking until the engine runs.

As soon as the engine runs

Return engine to idle speed:

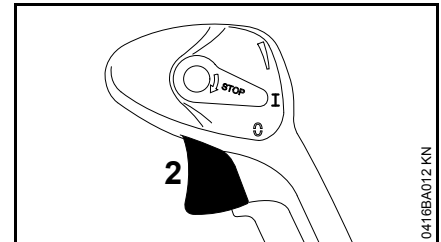

- Blip the throttle trigger – the choke knob automatically returns to “I”

or

- Turn the choke knob to the “I”-

At very low outside temperatures

- Open throttle slightly – warm up the engine for a short period.

Stopping the Engine

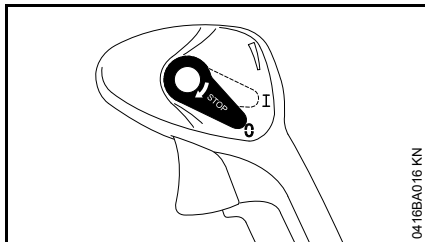

- Push the setting lever in the direction of ① – the engine stops – the setting lever then springs back automatically.

If engine does not start

Choke knob

If you did not turn the choke knob to  quickly enough after the engine began to fire, the combustion chamber is flooded.

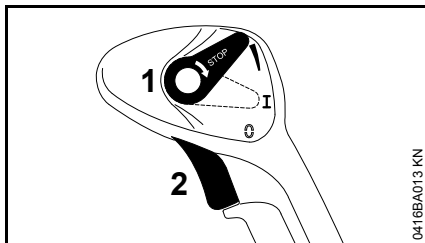

- Push the setting lever (1) upwards. The throttle trigger (2) is in the full throttle position.
- Continue cranking until the engine runs.

Other Hints on Starting

If the engine does not start

- Check that all settings are correct.
- Check that there is fuel in the tank and refuel if necessary.
- Check that the spark plug boot is properly connected.
- Repeat the starting procedure.
- Check adjustment of throttle cable – see chapter on "Adjusting the Throttle Cable".

Engine stalls in cold start position or under acceleration

- Move the choke knob to  and continue cranking until the engine runs.

Engine does not start in warm start position

- Move the choke knob to  and continue cranking until the engine runs.

Fuel tank run until completely dry

- After refueling, press the manual fuel pump bulb at least five times – even if the bulb is filled with fuel.
- Set the choke knob according to engine temperature.
- Now start the engine.

Operating Instructions

During Operation

After a long period of full throttle operation, allow the engine to run for a short while at idle speed so that engine heat can be dissipated by the flow of cooling air. This helps protect engine-mounted components (ignition, carburetor) from thermal overload.

After Finishing Work

Storing for a short period: Wait for the engine to cool down. Keep the machine in a dry place, well away from sources of ignition, until you need it again. For longer out-of-service periods – see "Storing the Machine".

Replacing the Air Filter

Dirty air filters reduce engine power, increase fuel consumption and make starting more difficult.

If there is a noticeable loss of engine power

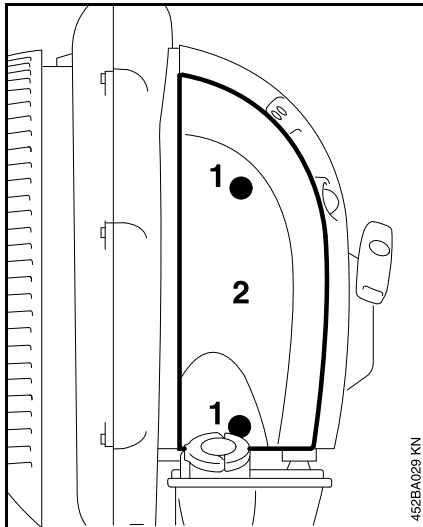

- Turn the choke knob to .
- Loosen the screws (1).
- Remove the filter cover (2).

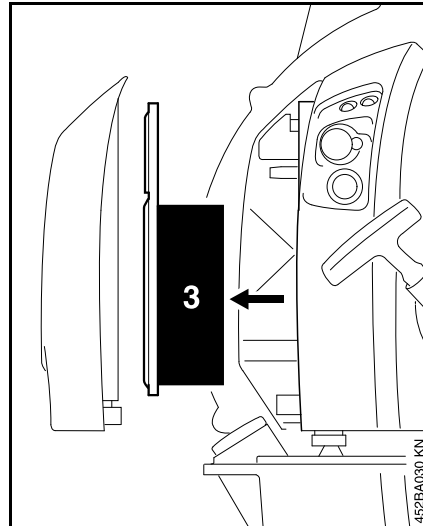

- Remove the filter element (3).
- Replace dirty or damaged filters.
- Fit the new filter in the filter housing.
- Fit the filter cover.
- Insert the screws and tighten them down firmly.

Adjusting the Carburetor

Adjusting Idle Speed

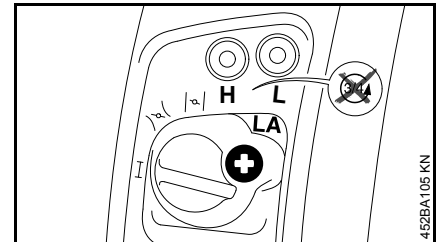

Engine stops while idling:

- Turn the idle speed screw (LA) slowly clockwise until the engine runs smoothly.

Spark Plug

- If the engine is down on power, difficult to start or runs poorly at idle speed, first check the spark plug.
- Fit a new spark plug after about 100 operating hours – or sooner if the electrodes are badly eroded. Install only suppressed spark plugs of the type approved by STIHL – see "Specifications".

Removing the Spark Plug

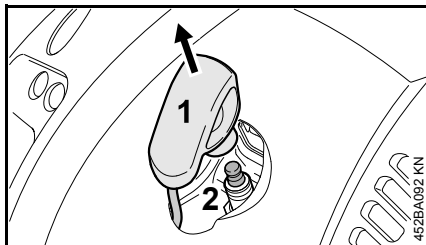

- Pull off the spark plug boot (1).
- Unscrew the spark plug (2).

Checking the Spark Plug

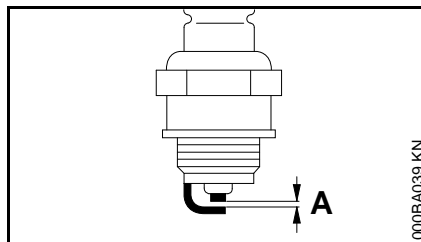

- Clean dirty spark plug.
- Check electrode gap (A) and readjust if necessary – see "Specifications".
- Rectify the problems which have caused fouling of the spark plug.

Possible causes are:

- Too much oil in fuel mix.
- Dirty air filter.
- Unfavorable running conditions.

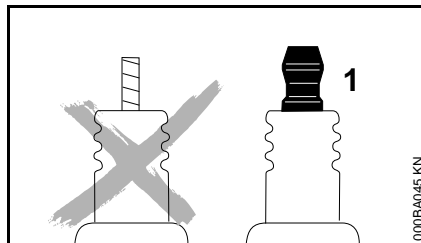

! WARNING

Arcing may occur if the adapter nut (1) is loose or missing. Working in an easily combustible or explosive atmosphere may cause a fire or an explosion. This can result in serious injuries or damage to property.

- Use resistor type spark plugs with a properly tightened adapter nut.

Installing the spark plug

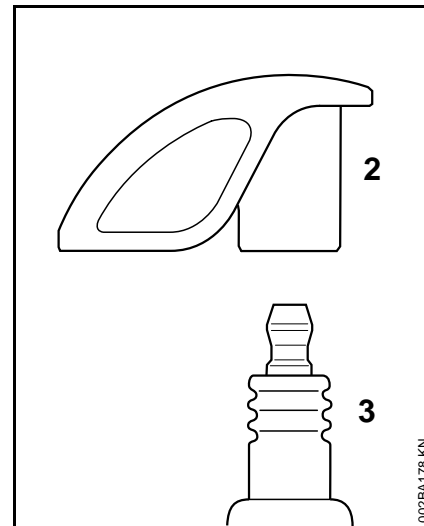

- Screw the spark plug (3) into the cylinder and fit the boot (2) (press it down firmly).

Storing the Machine

For periods of 3 months or longer

- Drain and clean the fuel tank in a well ventilated area.
- Dispose of fuel properly in accordance with local environmental requirements.
- Run the engine until the carburetor is dry – this helps prevent the carburetor diaphragms sticking together.
- Thoroughly clean the machine – pay special attention to the cylinder fins and air filter.
- Store the machine in a dry, high or locked location, – out of the reach of children and other unauthorized persons.

Inspections and Maintenance by Dealer

Fuel pickup body in tank

- Have the pickup body in the fuel tank replaced every year.

STIHL recommends that you have servicing and repair work carried out exclusively by an authorized STIHL servicing dealer.

Maintenance and Care

| The following intervals apply to normal operating conditions only. If your daily working time is longer or operating conditions are difficult (very dusty work area, etc.), shorten the specified intervals accordingly. | | before starting work | after finishing work or daily | after each refueling stop | weekly | monthly | every 12 months | if problem | if damaged | as required |
|--|--|----------------------|-------------------------------|---------------------------|--------|---------|-----------------|------------|------------|-------------|
| | | | | | | | | | | |
| Complete machine | Visual inspection (condition, leaks) | X | | X | | | | | | |
| | Clean | | X | | | | | | | |
| Control handle | Check operation | X | | X | | | | | | |
| Air filter | Replace | | | | | | | X | | |
| Manual fuel pump | Check | X | | | | | | | | |
| | Have repaired by servicing dealer ¹⁾ | | | | | | | | X | |
| Filter in fuel tank | Have checked by servicing dealer ¹⁾ | | | | | | | X | | |
| | Have filter replaced by dealer ¹⁾ | | | | | | X | | | X |
| Fuel tank | Clean | | | | | X | | | | |
| Carburetor | Check idle adjustment | X | | X | | | | | | |
| | Readjust idle | | | | | | | | | X |
| Spark Plug | Readjust electrode gap | | | | | | | X | | |
| | Replace after every 100 operating hours | | | | | | | | | |
| Cooling inlet | Visual inspection | | X | | | | | | | |
| | Clean | | | | X | | | | | |
| Valve clearance | Have checked and, if necessary, adjusted by dealer after first 139 hours of operation ¹⁾ | | | | | | | | | X |
| Combustion chamber | Have decoked by servicing dealer ¹⁾ after first 139 hours of operation, then every 150 hours of operation | | | | | | | | | X |
| All accessible screws and nuts (not adjusting screws) | Retighten | | | | | | | | | X |
| Anti-vibration elements | Check | X | | | | | | | | |
| | Have replaced by servicing dealer ¹⁾ | | | | | | | X | X | |

| The following intervals apply to normal operating conditions only. If your daily working time is longer or operating conditions are difficult (very dusty work area, etc.), shorten the specified intervals accordingly. | | before starting work | after finishing work or daily | after each refueling stop | weekly | monthly | every 12 months | if problem | if damaged | as required |
|--|---------|----------------------|-------------------------------|---------------------------|--------|---------|-----------------|------------|------------|-------------|
| Blower air intake screen | Check | X | | X | | | | | | |
| | Clean | | | | | | | | | X |
| Base plate | Check | X | | X | | | | | | |
| | Clean | | | | | | | | | X |
| Throttle cable | Adjust | | | | | | | | | X |
| Safety labels | Replace | | | | | | | | X | |

1) STIHL recommends an authorized STIHL servicing dealer.

Minimize Wear and Avoid Damage

Observing the instructions in this manual helps reduce the risk of unnecessary wear and damage to the power tool.

The power tool must be operated, maintained and stored with the due care and attention described in this owner's manual.

The user is responsible for all damage caused by non-observance of the safety precautions, operating and maintenance instructions in this manual. This includes in particular:

- Alterations or modifications to the product not approved by STIHL.
- Using tools or accessories which are neither approved or suitable for the product or are of a poor quality.
- Using the product for purposes for which it was not designed.
- Using the product for sports or competitive events.
- Consequential damage caused by continuing to use the product with defective components.

Maintenance Work

All the operations described in the "Maintenance Chart" must be performed on a regular basis. If these maintenance operations cannot be performed by the owner, they should be performed by a servicing dealer.

STIHL recommends that you have servicing and repair work carried out exclusively by an authorized STIHL

servicing dealer. STIHL dealers are regularly given the opportunity to attend training courses and are supplied with the necessary technical information.

If these maintenance operations are not carried out as specified, the user assumes responsibility for any damage that may occur. Among other parts, this includes:

- Damage to the engine due to neglect or deficient maintenance (e.g. air and fuel filters), incorrect carburetor adjustment or inadequate cleaning of cooling air inlets (intake ports, cylinder fins).
- Corrosion and other consequential damage resulting from improper storage.
- Damage to the machine resulting from the use of poor quality replacement parts.

Parts Subject to Wear and Tear

Some parts of the power tool are subject to normal wear and tear even during regular operation in accordance with instructions and, depending on the type and duration of use, have to be replaced in good time. Among other parts, this includes:

- Filters (air, fuel)
- Rewind starter
- Spark plug
- Damping elements of anti-vibration system

Main Parts

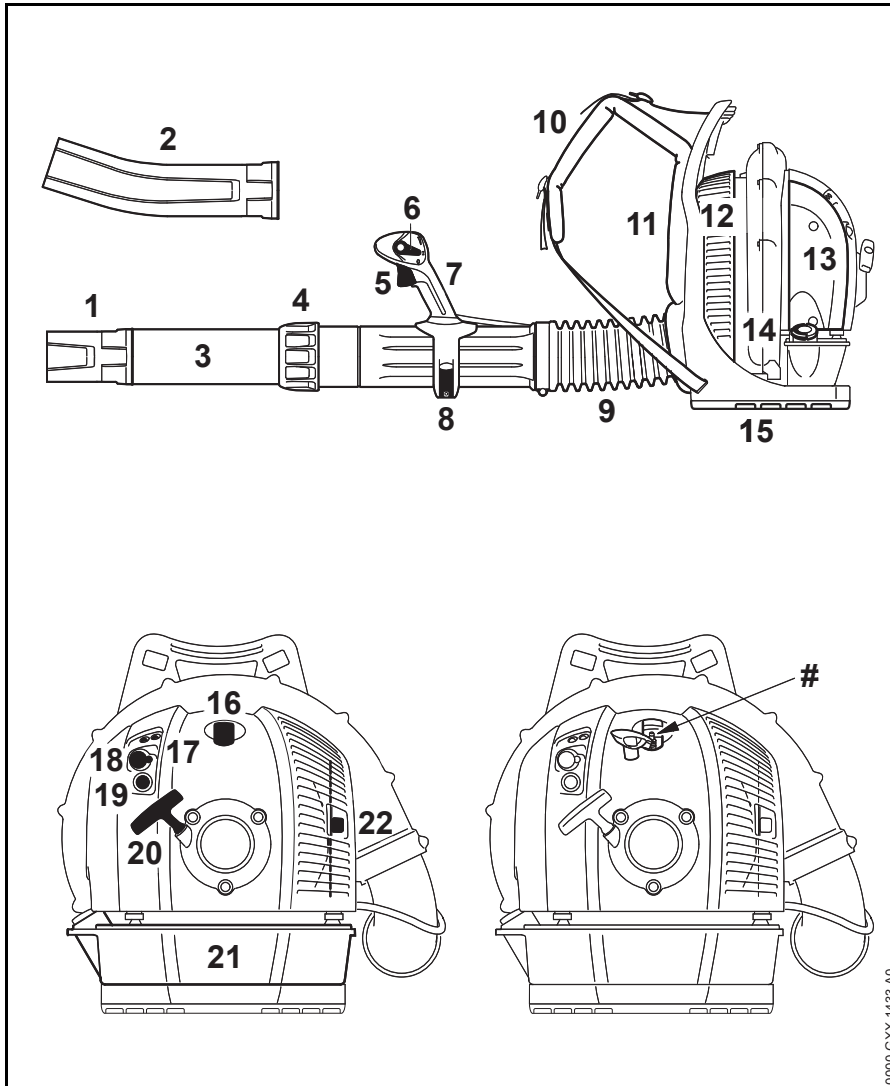

- 1 Straight nozzle¹⁾
- 2 Curved nozzle¹⁾
- 3 Blower tube
- 4 Union nut
- 5 Throttle trigger
- 6 Setting lever
- 7 Control handle
- 8 Clamping lever
- 9 Pleated hose
- 10 Harness
- 11 Backplate
- 12 Intake screen
- 13 Air filter
- 14 Tank cap
- 15 Base plate
- 16 Spark plug boot
- 17 Carburetor adjusting screws
- 18 Choke knob
- 19 Manual fuel pump
- 20 Starter grip
- 21 Fuel tank
- 22 Muffler
- # Serial Number

¹⁾ Not in all versions, country-specific

Specifications

Engine

STIHL 4-MIX Engine

| | |
|---------------|-----------|
| Displacement: | 64.8 cc |
| Bore: | 50 mm |
| Stroke: | 33 mm |
| Idle speed: | 2,500 rpm |

Ignition System

Electronic magneto ignition

| | |
|-----------------------------|-------------------------------|
| Spark plug (resistor type): | NGK CMR 6 H, BOSCH USR 4AC |
| Electrode gap: | 0.5 mm |

Fuel System

All position diaphragm carburetor with integral fuel pump

Fuel tank capacity: 1400 cc (1.4 l)

Blowing Performance

| | |
|--|------------------------|
| Blowing force: | 35 N |
| Air velocity: | 74 m/s |
| Air flow rate: | 1550 m ³ /h |
| Maximum air velocity: | 88 m/s |
| Maximum air flow rate with-out blower tube assembly: | 1860 m ³ /h |

Weight

dry: 10.8 kg

Noise and Vibration Data

Noise and vibration data are measured at idling and maximum rated speed in a ratio of 1:6.

For further details on compliance with Vibration Directive 2002/44/EC see www.stihl.com/vib.

Sound pressure level L_p to DIN EN ISO 22868

BR 700: 101 dB(A)

Sound power level L_w to DIN EN ISO 22868

BR 700: 109 dB(A)

Vibration measurement $a_{hv,eq}$ to DIN EN ISO 22867

Standard version

| | |
|---------|----------------------|
| | Handle, right |
| BR 700: | 2.5 m/s ² |

Version with bike handle

| | | |
|---------|----------------------|----------------------|
| | Handle, left | Handle, right |
| BR 700: | 2.5 m/s ² | 2.5 m/s ² |

The K-factor in accordance with Directive 2006/42/EC is 2.5 dB(A) for the sound pressure level and sound power level; the K-factor in accordance with Directive 2006/42/EC is 2.0 m/s² for the vibration measurement.

REACH

REACH is an EC regulation and stands for the Registration, Evaluation, Authorisation and Restriction of Chemical substances.

For information on compliance with the REACH regulation (EC) No. 1907/2006 see www.stihl.com/reach.

Maintenance and Repairs

Users of this machine may only carry out the maintenance and service work described in this user manual. All other repairs must be carried out by a servicing dealer.

STIHL recommends that you have servicing and repair work carried out exclusively by an authorized STIHL servicing dealer. STIHL dealers are regularly given the opportunity to attend training courses and are supplied with the necessary technical information.

When repairing the machine, only use replacement parts which have been approved by STIHL for this power tool or are technically identical. Only use high-quality replacement parts in order to avoid the risk of accidents and damage to the machine.

STIHL recommends the use of original STIHL replacement parts.

Original STIHL parts can be identified by the STIHL part number, the **STIHL** logo and the STIHL parts symbol  (the symbol may appear alone on small parts).

Disposal

Observe all country-specific waste disposal rules and regulations.

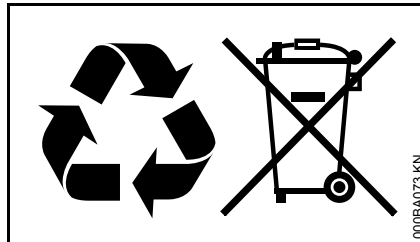

STIHL products must not be thrown in the garbage can. Take the product, accessories and packaging to an approved disposal site for environment-friendly recycling.

Contact your STIHL servicing dealer for the latest information on waste disposal.

EC Declaration of Conformity

ANDREAS STIHL AG & Co. KG
Badstr. 115
D-71336 Waiblingen

Germany

declare in exclusive responsibility that the product

| | |
|------------------------|---------|
| Category: | Blower |
| Make: | STIHL |
| Model: | BR 700 |
| Serial identification: | 4282 |
| Displacement: | 64.8 cc |

conforms to the relevant provisions of Directives 2006/42/EC, 2014/30/EU and 2000/14/EC and has been developed and manufactured in compliance with the following standards in the versions valid on the date of production:

EN ISO 12100, EN 15503, EN 55012, EN 61000-6-1

The measured and guaranteed sound power levels were determined according to Directive 2000/14/EC, Annex V, using the ISO 11094 standard.

Measured sound power level

BR 700: 107 dB(A)

Guaranteed sound power level

BR 700: 109 dB(A)

Technical documents deposited at:

ANDREAS STIHL AG & Co. KG
Produktzulassung (Product Licensing)

The year of manufacture and serial number are applied to the product.

Done at Waiblingen, 28.10.2016

ANDREAS STIHL AG & Co. KG

A handwritten signature in black ink, reading "Thomas Elsner". The signature is written in a cursive style with a large initial 'T' and 'E'.

Thomas Elsner

Director Product Management and
Services

The CE mark, consisting of the letters 'C' and 'E' in a bold, sans-serif font, positioned side-by-side.

0458-459-0121-B

englisch



www.stihl.com



0458-459-0121-B